

**COBA**

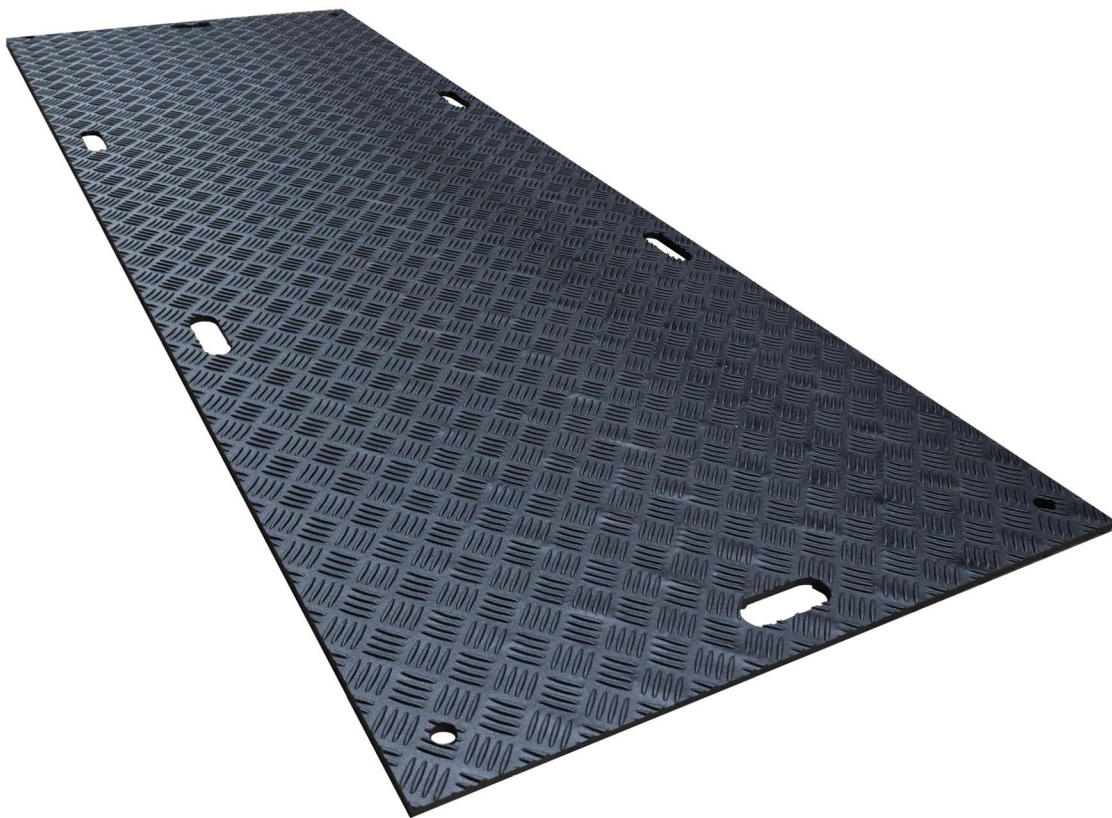

## Installation Guidelines

### COBATrack Mat



**fire  
& safety  
centre**

**Available From:**

Fire and Safety Centre

15 Atkinsons Way, Foxhills Industrial Estate

Scunthorpe, North Lincolnshire, DN15 8QJ

**Tel:** 01724 281044 **Web:** [www.fireandsafetycentre.co.uk](http://www.fireandsafetycentre.co.uk)

**Email:** [sales@fireandsafetycentre.co.uk](mailto:sales@fireandsafetycentre.co.uk)

## Tools & Materials

### Tools

Allen Key

Socket set / Spanner (PU Version only)

### Materials

COBATrack Mat

Connectors (PU / Steel)

\*Installation requires atleast 2 people

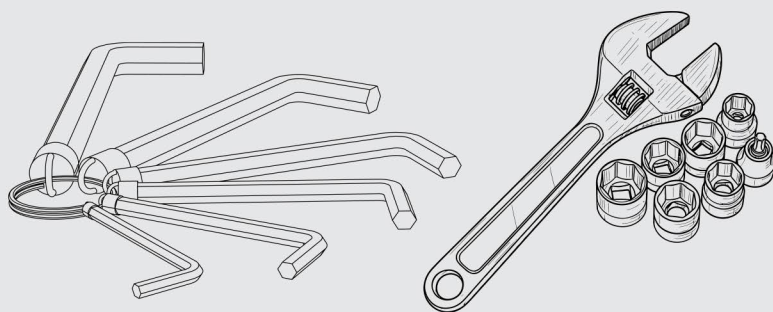

### COBATrack Mat

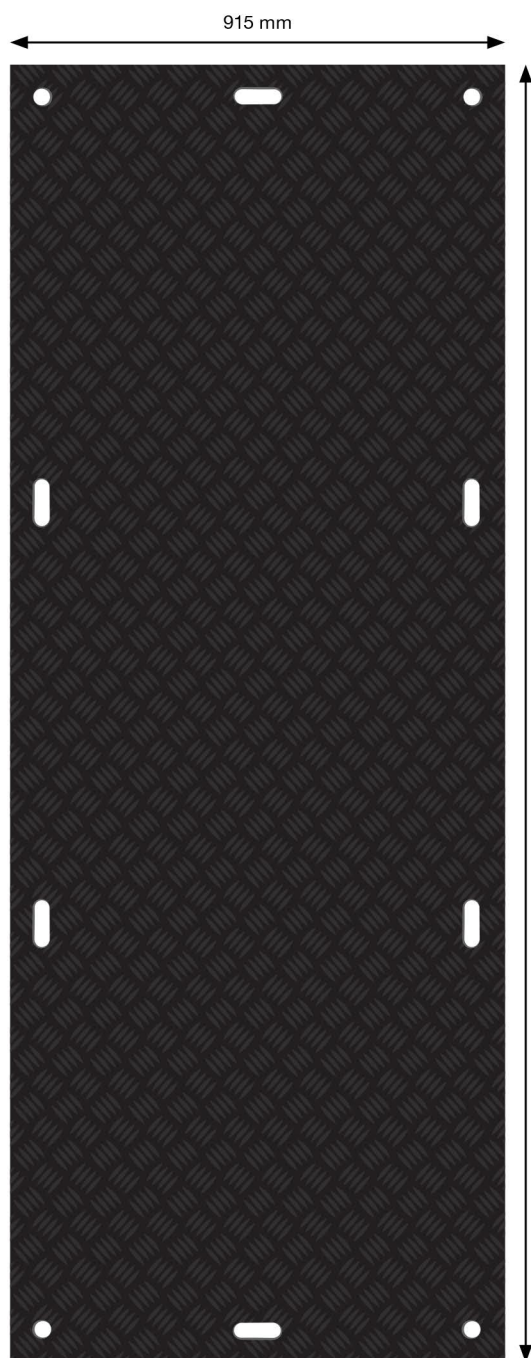

### Steel Connector

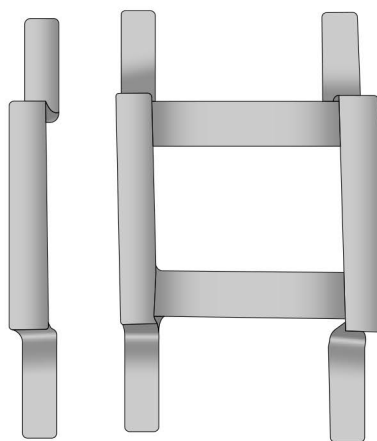

### PU Double Connector

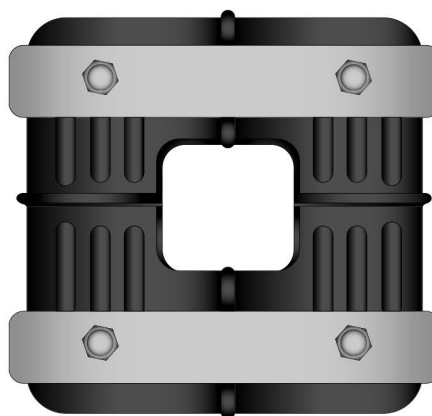

### PU Single Connector



**fire  
& safety  
centre**

### Available From:

Fire and Safety Centre

15 Atkinsons Way, Foxhills Industrial Estate

Scunthorpe, North Lincolnshire, DN15 8QJ

Tel: 01724 281044 Web: [www.fireandsafetycentre.co.uk](http://www.fireandsafetycentre.co.uk)

Email: [sales@fireandsafetycentre.co.uk](mailto:sales@fireandsafetycentre.co.uk)

## Installation

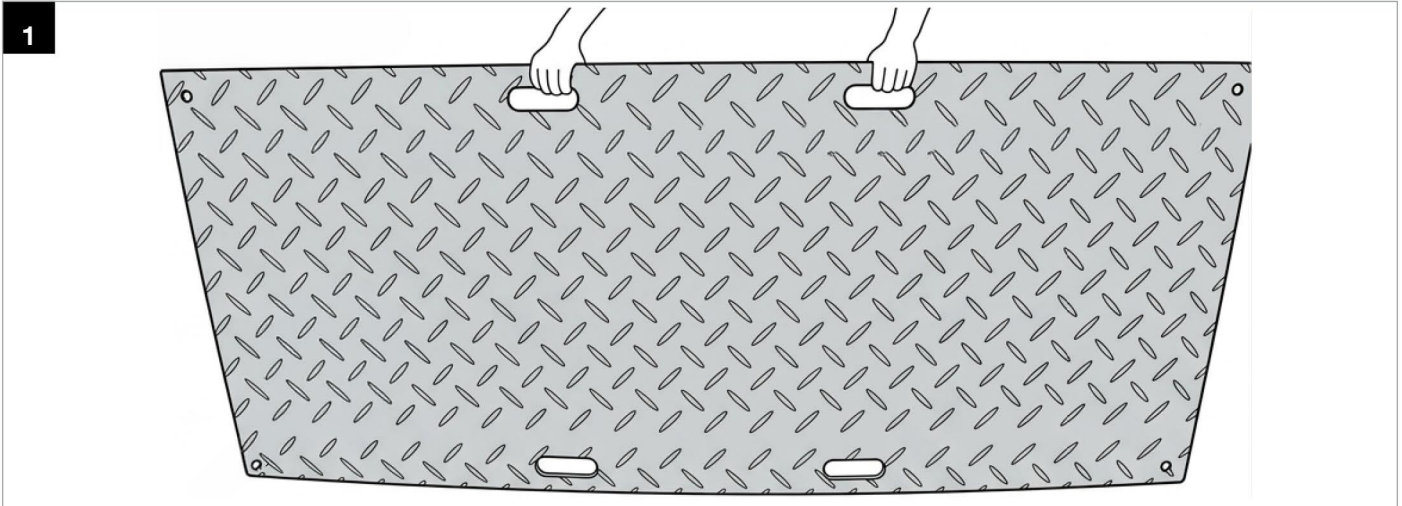

**2** Place one end of the Steel Connector into the designated slot and with 2 HD mats at a right angle to each other.

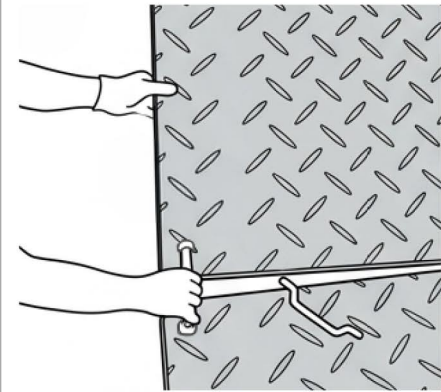

**3** Place the other end of the Steel Connector into the opposing mat.

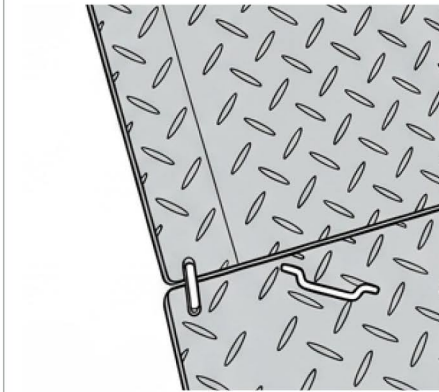

**4** Once both Steel Connectors are in place, lay the upright HD mat onto the ground so both HD mats are side by side.

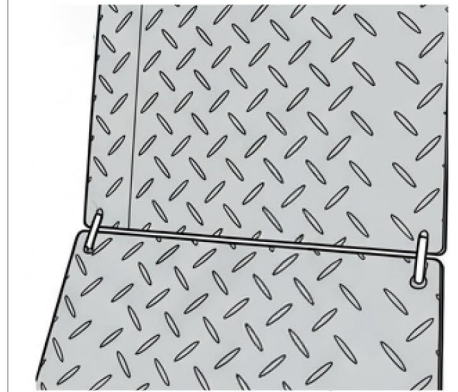

**5**

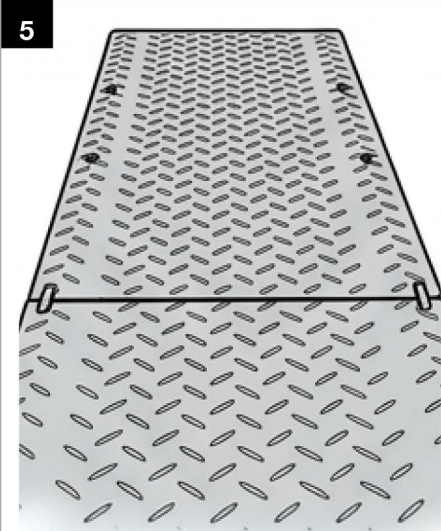

**6** Continue process in whichever direction is required until area is sufficiently covered.

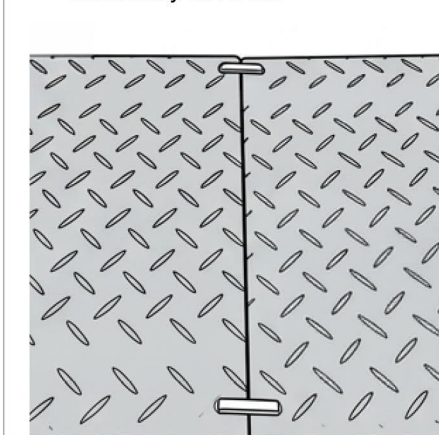

**7** To remove HD mats, simply follow the same process, in reverse.

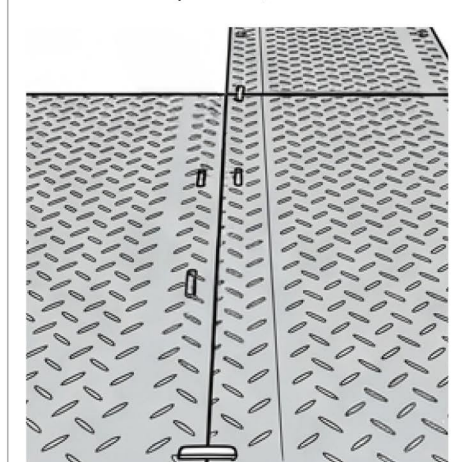

PU Connectors can be locked in place using a socket/allen key, whilst HD mats are laid down side by side, in any direction.

## Types of Connectors

### 1 PU Connectors:

- Easy to install and disassemble
- Can be reused

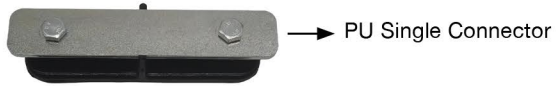

PU Single Connector

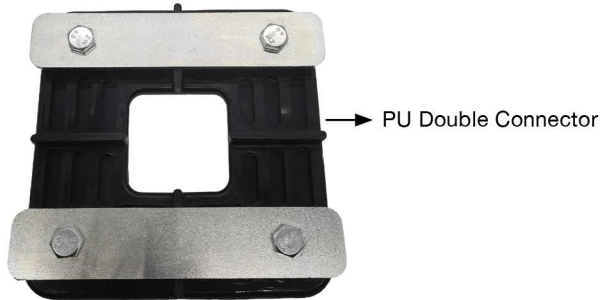

PU Double Connector

### 2 Steel Connectors:

- Install firmly
- Will not tear apart
- Cost-effective
- Can be reused



Steel Single Connector

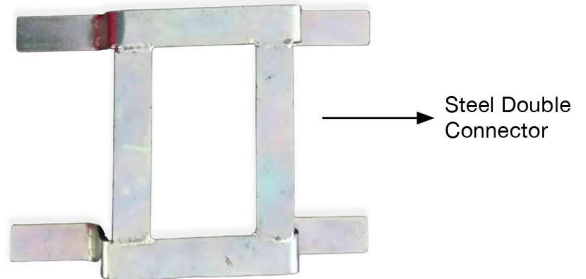

Steel Double Connector

#### Available From:

Fire and Safety Centre

15 Atkinsons Way, Foxhills Industrial Estate

Scunthorpe, North Lincolnshire, DN15 8QJ

**Tel:** 01724 281044 **Web:** [www.fireandsafetycentre.co.uk](http://www.fireandsafetycentre.co.uk)

**Email:** [sales@fireandsafetycentre.co.uk](mailto:sales@fireandsafetycentre.co.uk)